

K HUS

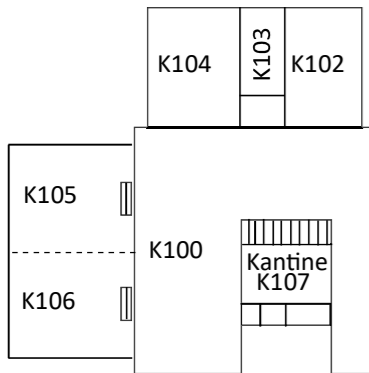

N HUS

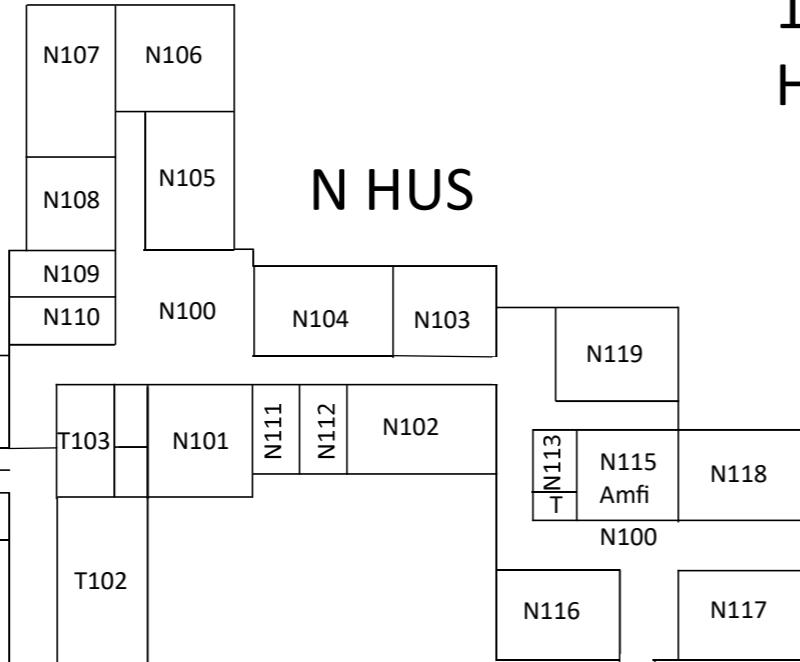

1.SAL H HUS

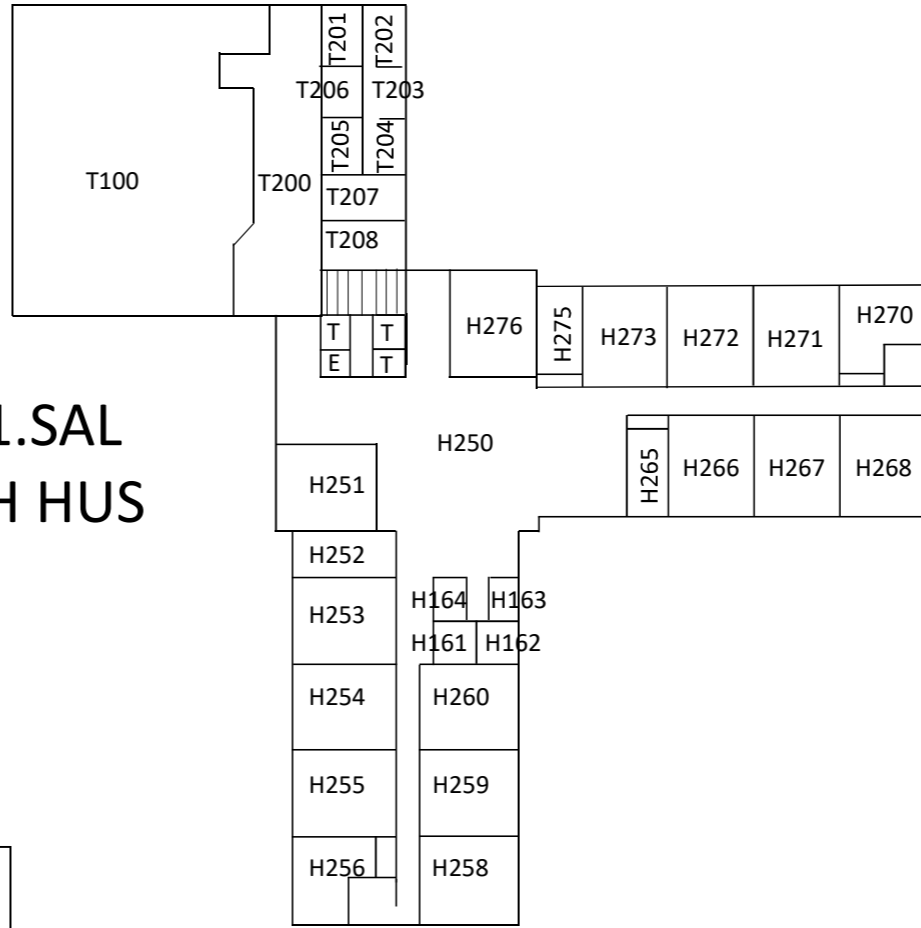

KÆLDER A OG K HUS

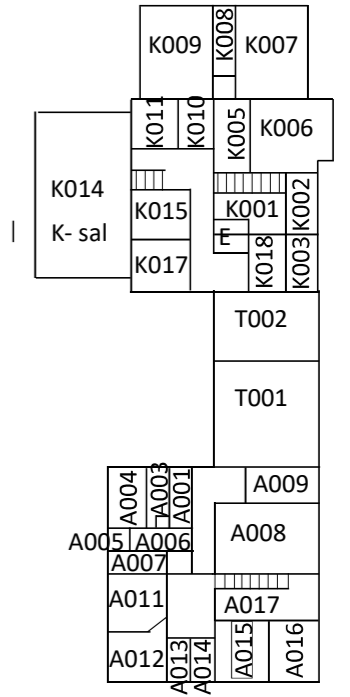

A HUS

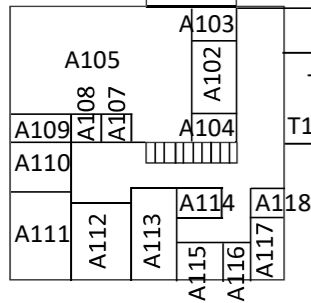

H HUS

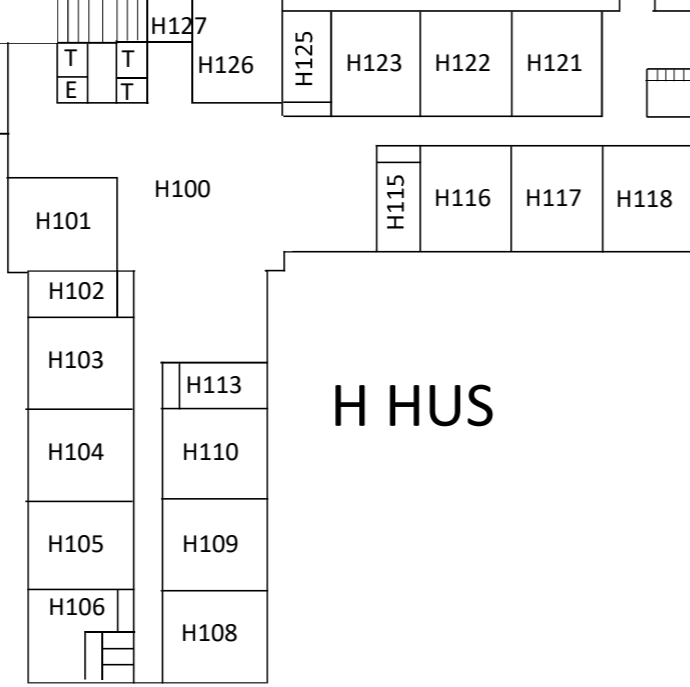

IDRÆTSBYEN

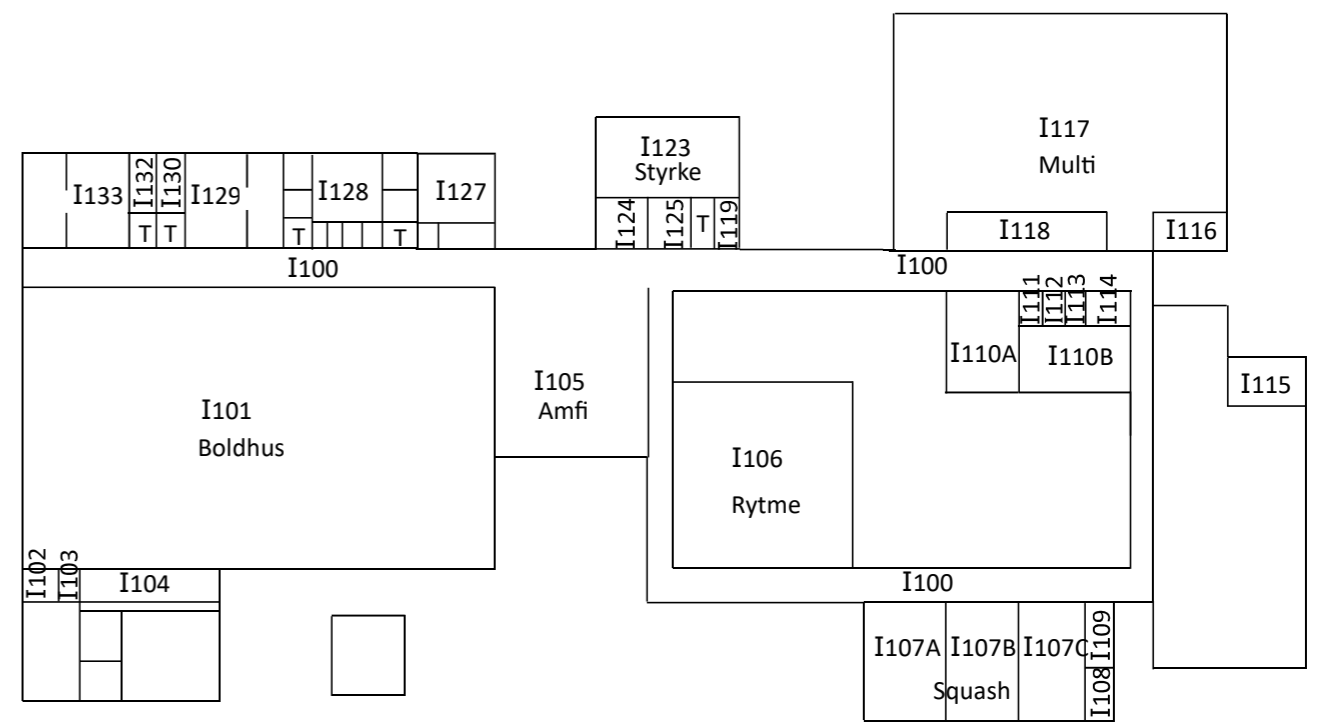

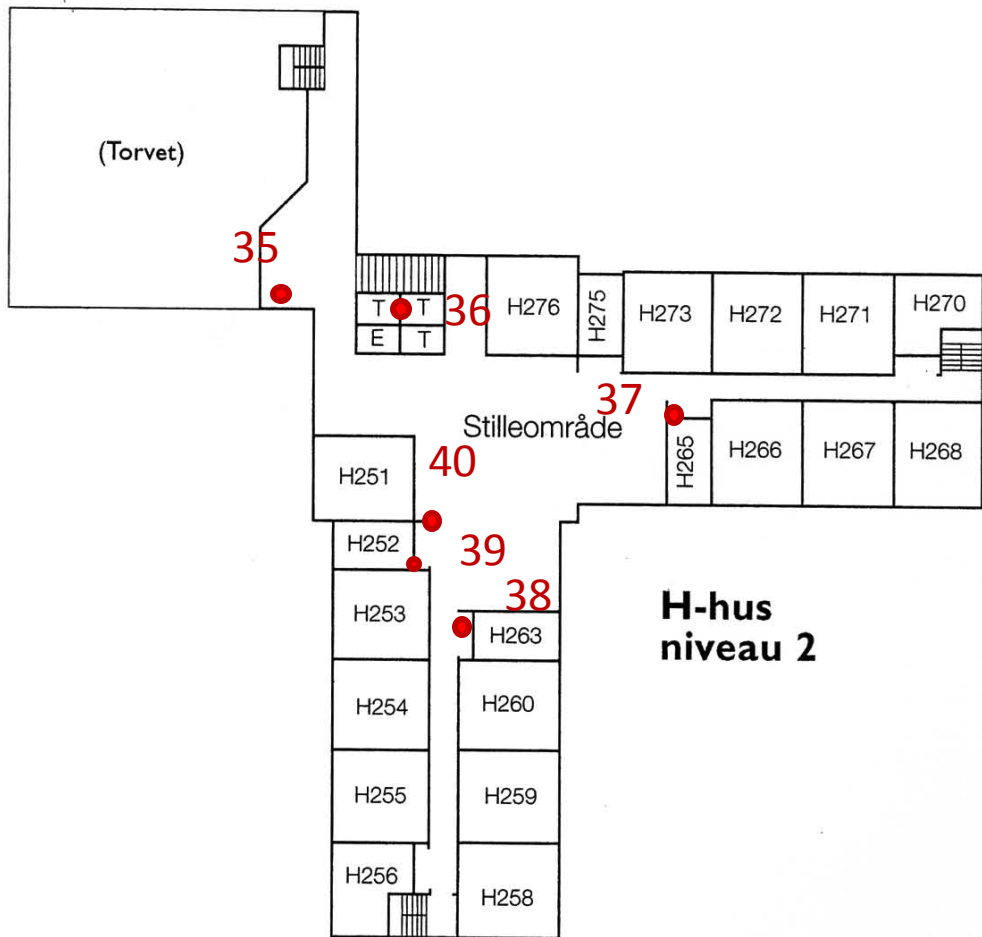

**Kælder
A & K-hus**

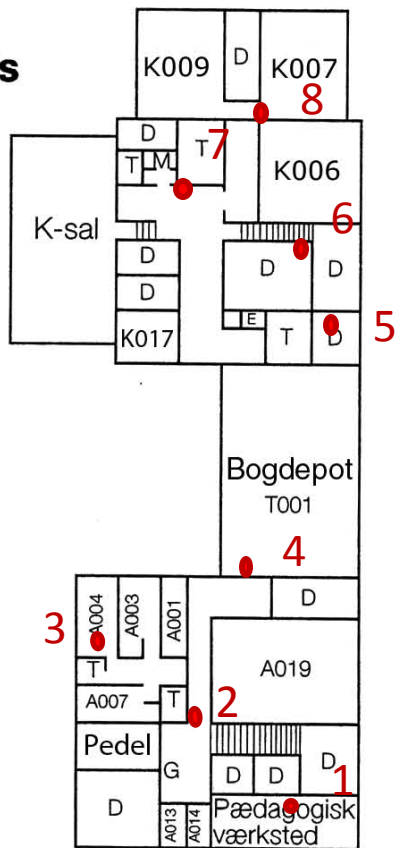

K-hus

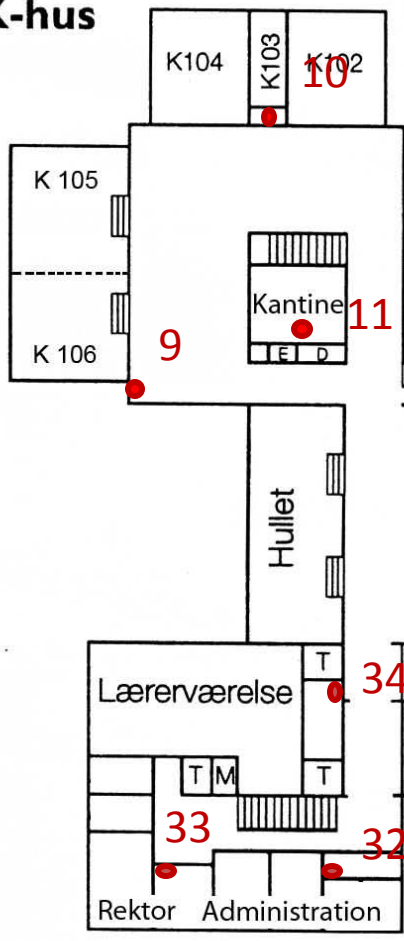

N-hus

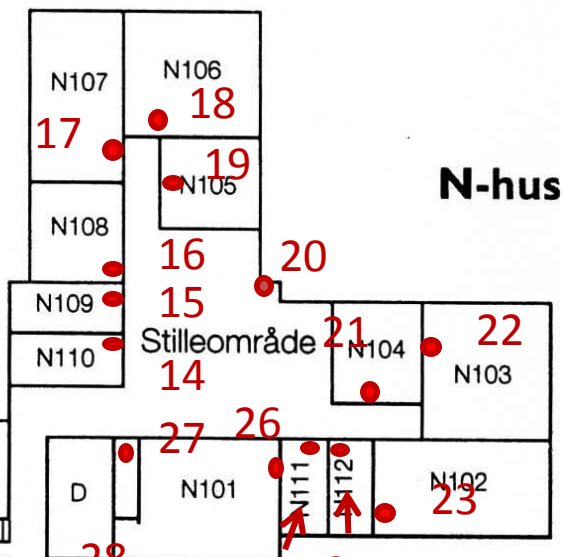

Studiecenter

Torv

A-hus

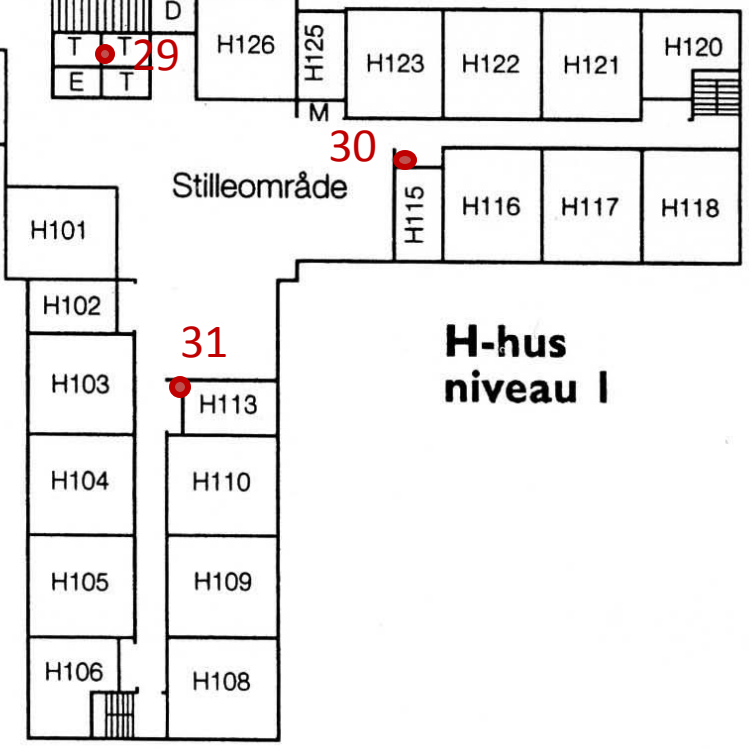

H-hus niveau I

Hovedindgang



Tilbage til grundplan

1

Pædagogisk værksted



 Tilbage til grundplan

2

Gang K-hus kælder





Tilbage til grundplan

3

Pedel værksted





Tilbage til grundplan

Bogdepot

4





Tilbage til grundplan

5

Bratterirum.





7

Slangevinding i gang i K-Hus



 Tilbage til grundplan

Gang til Formning/Geografi





Tilbage til grundplan

9

Kantinen øverste del



10



Tilbage til grundplan

Gang ved musik.





Tilbage til grundplan

Kantinen





Tilbage til grundplan

12

Torvet





Tilbage til grundplan

13

Torvet





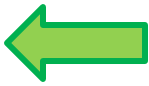

Tilbage til grundplan

N-109

15





Tilbage til grundplan

N-108

16



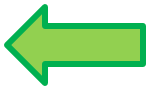

Tilbage til grundplan

N-107

17





Tilbage til grundplan

N-106

18



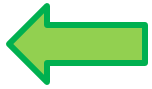

Tilbage til grundplan

N-105

19





Tilbage til grundplan

20

Stilleområde N-hus



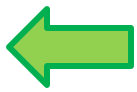

Tilbage til grundplan

N-104

21



 Tilbage til grundplan

N-103

22





Tilbage til grundplan

23

N-102





Tilbage til grundplan

N-112

24





Tilbage til grundplan

25

N-111





Tilbage til grundplan

26

N-101





Tilbage til grundplan

Teknikrum N-Hus

27





Tilbage til grundplan

Teknikrum bag toilet stuen H-Hus

29





Tilbage til grundplan

Slangevinding H-115 (Tysk)

30





Tilbage til grundplan

31

Slangevinding H-113





Tilbage til grundplan

32

Kopirum adm.

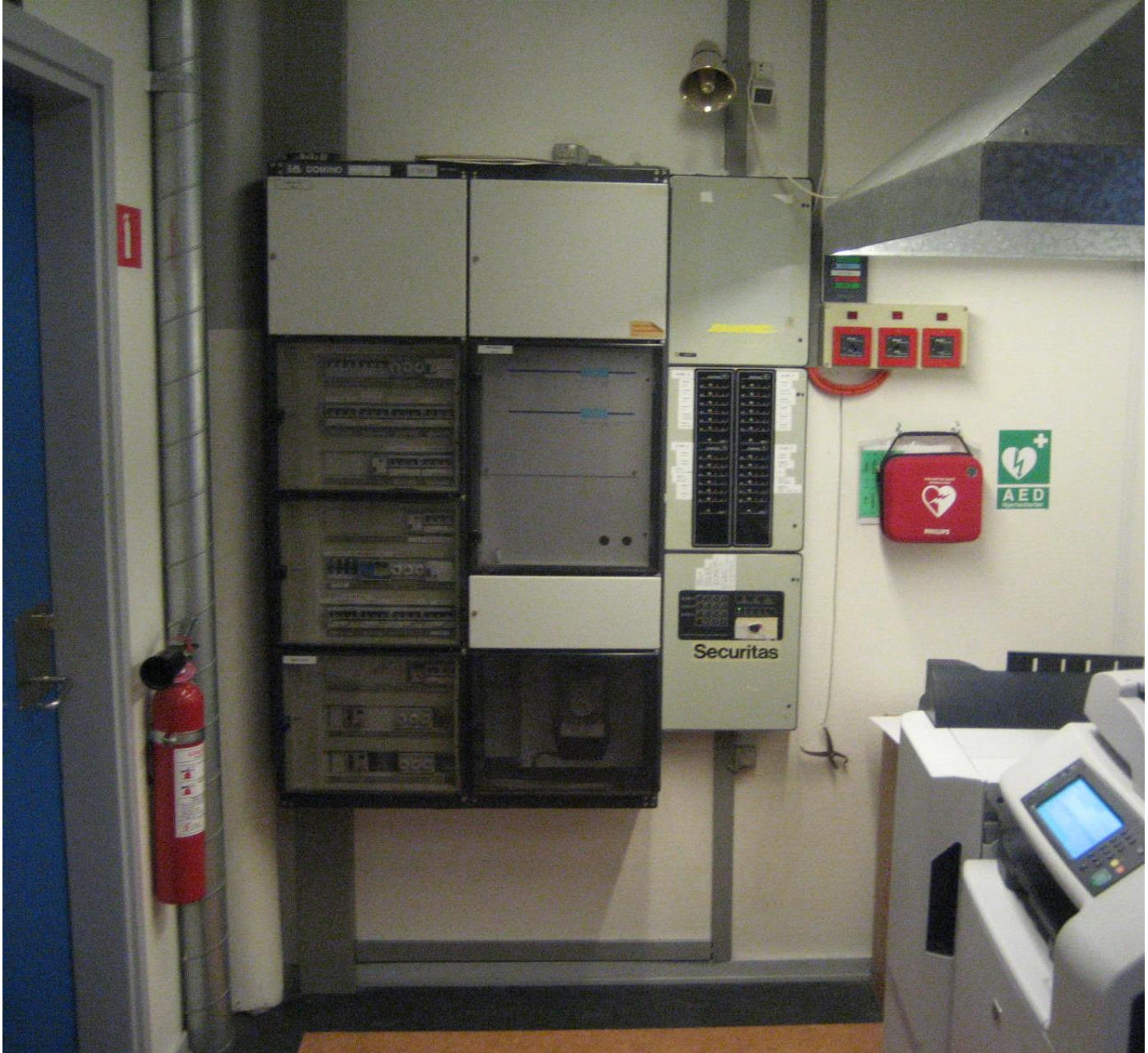



Tilbage til grundplan

A-112 (Tina og Trine)

33





Tilbage til grundplan

34

Læreværelse





Tilbage til grundplan

Slangevinding balkon

35





Tilbage til grundplan

36

Teknikrum bag toilet 1. sal H-Hus





Tilbage til grundplan

Slangevinding H-265 (Samfundsfag/Psykologi)

37





Tilbage til grundplan

38

Slangevinding H-263 (studievejledning)





Tilbage til grundplan

39

H-252





Tilbage til grundplan

40

Stilleområde ved H-252





Tilbage til grundplan

41

Hallen trappe til lille hal





Tilbage til grundplan

42

Hallen teknikrum bag rengøringsrum.





Tilbage til grundplan

43

Hallen trappe mod store hal





Tilbage til grundplan

44

Maskinrum ved varmecentral





Tilbage til grundplan

45

Varmecentral



